

# MULTI-FUNCTIONAL POWER CAGE WITH CABLE MACHINE

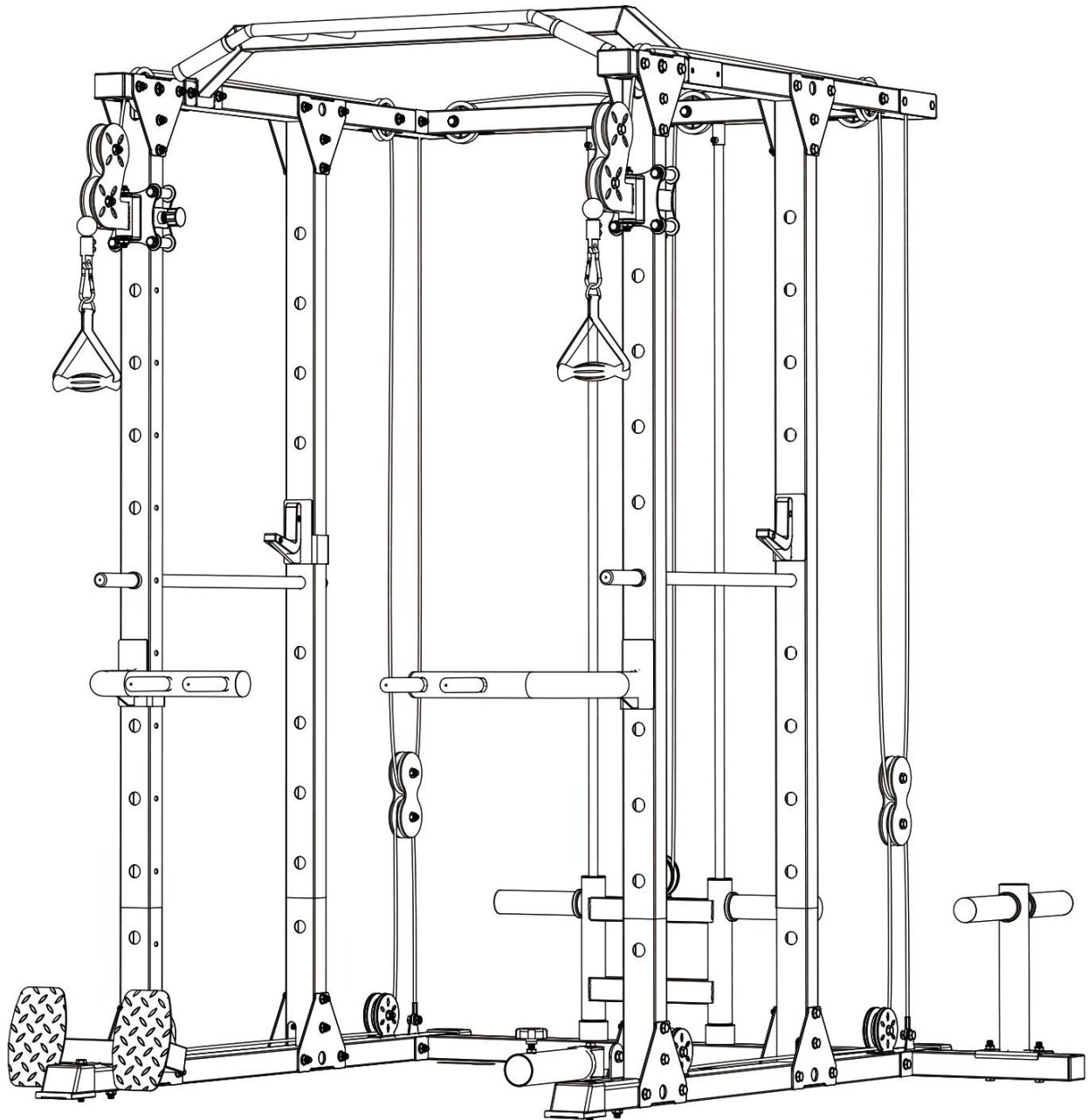

# Cautions

## Security precautions

To ensure your safety, please read the following notes before using this product read study and understand the instructions and all warning labels before use.

1. It is recommended to be familiar with the regular operation and usage of the apparatus before using this product. Relevant information is available on these instruction sheets well as at local retailers.

2. Be sure to keep this specification and ensure that all warning labels are clear and complete.

3. This product is recommended for installation by more than two people.

4. Ask a doctor for advice before you start exercising.

5. Please keep your hands, limbs, and clothes stretch so that you can fully and safely use.

6. Note any possible signs of mechanical occurrence, including party wear, hardware loosening, and welding cracks. If any of the above symptoms, immediately stop using this device and contact our after-sales service department. You can use a wrench to complete the assembly.

7. The user of this product shall not exceed 330 lbs.

**PARTS LIST**

**A1. BASE LEFT**

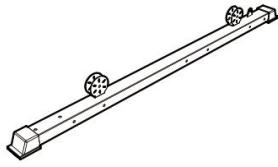

1pc

**A2. BASE RIGHT**

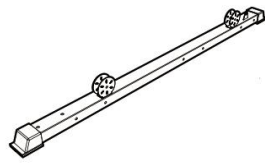

1pc

**B. BEAR CROSS BASE**

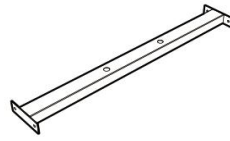

1pc

**C. UPPER CROSS FRAME**

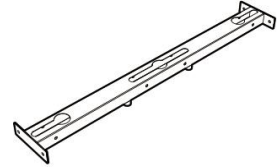

1pc

**D1. D2. UPPER FRAME**

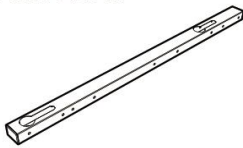

2pc

**E. PULL-UP FRAME**

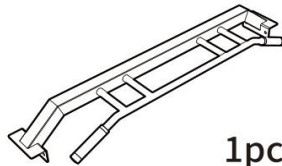

1pc

**W. BAR CATCH**

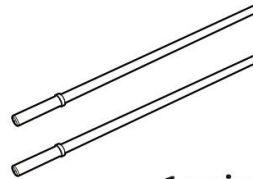

1pairs

**V. FIXED PIECE**

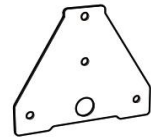

16pc

**G1. UPRIGHT LEFT**

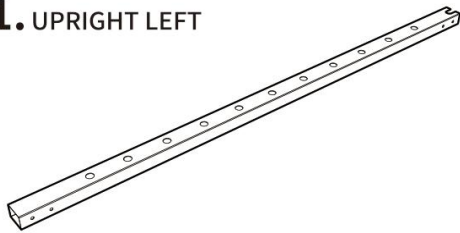

1pc

**G2. UPRIGHT RIGHT**

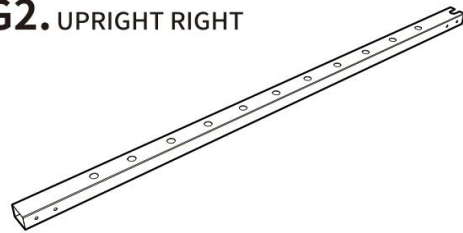

1pc

**G3. BEAR UPRIGHT LEFT**

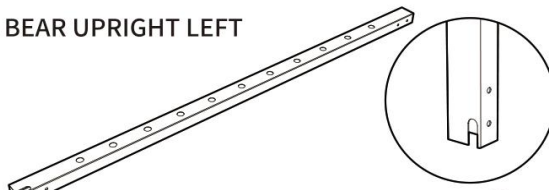

1pc

**G4. BEAR UPRIGHT LEFT**

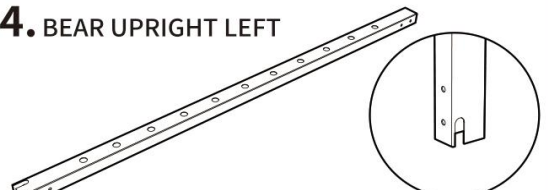

1pc

**H. GUIDE ROD (LONG)**

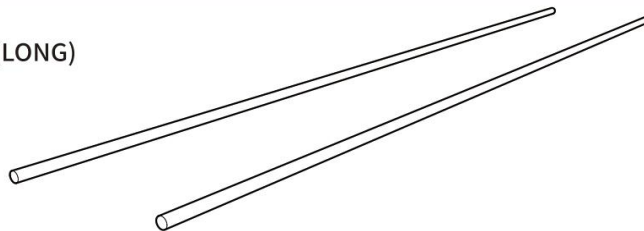

1pairs

**I. SHOCK PAD**



1pairs

**J. WEIGHT FRAME**

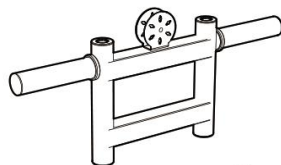

1pc

**K1. WEIGHT STORAGE RACK BASE**

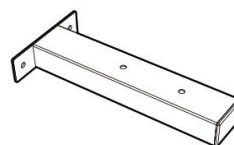

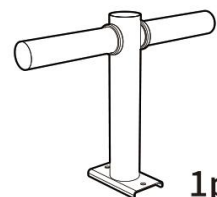

1pc

**K2. WEIGHT STORAGE RACK**



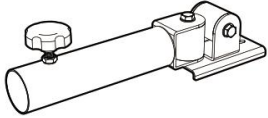
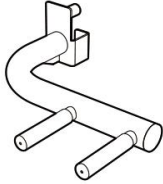
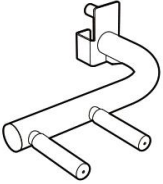
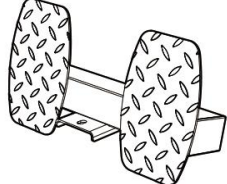
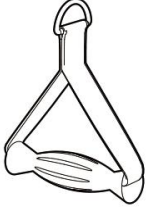
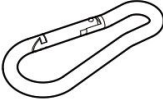
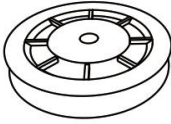
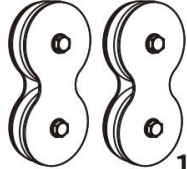
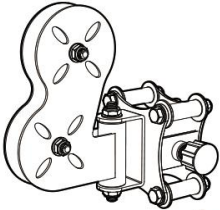
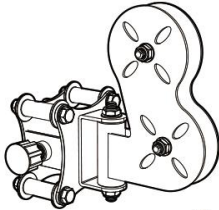
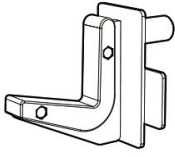
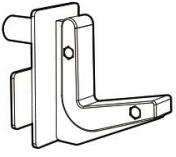

1pc

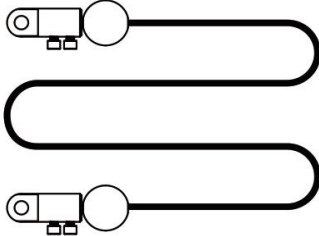
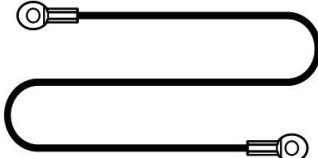
**PARTS LIST**

<p><b>L. WIGHT ROD SLEEVE</b></p>  <p>1pc</p>	<p><b>M1. HANDLEBAR LEFT</b></p>  <p>1pc</p>	<p><b>M2. HANDLEBAR RIGHT</b></p>  <p>1pc</p>	<p><b>N. PEDALS</b></p>  <p>1pc</p>
<p><b>O. CABLE HANDLEBAR</b></p>  <p>2pc</p>	<p><b>P. CLIP</b></p>  <p>2pc</p>	<p><b>Q. PULLEY</b></p>  <p>10pc</p>	<p><b>S. MOVING PULLEY</b></p>  <p>1pairs</p>
<p><b>R1. PULLEY SLIDING SLEEVE LEFT</b></p>  <p>1pc</p>	<p><b>R2. PULLEY SLIDING SLEEVE RIGHT</b></p>  <p>1pc</p>	<p><b>X1. J HOOK LEFT</b></p>  <p>1pc</p>	<p><b>X2. J HOOK RIGHT</b></p>  <p>1pc</p>
<p><b>T. KAVA</b></p>  <p>5pc</p>	<p><b>U. CABLE A</b></p>  <p>1pc</p>		<p><b>V. CABLE B</b></p>  <p>2 pc</p>

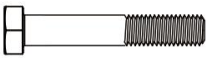
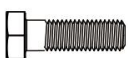
**HARDWARE LIST**

<p><b>Note:</b> Pulleys and screws are pre-installed on fittings</p>		<p><b>1. BOLT (M10*90)</b></p>  <p>54 pc</p>	
<p><b>2. BOLT (M10*70)</b></p>  <p>13 pc</p>	<p><b>3. BOLT (M10*25)</b></p>  <p>4 pc</p>	<p><b>4. WASHER (M10)</b></p>  <p>142 pc</p>	<p><b>5. WASHER (M10)</b></p>  <p>71 pc</p>



STEP 1.

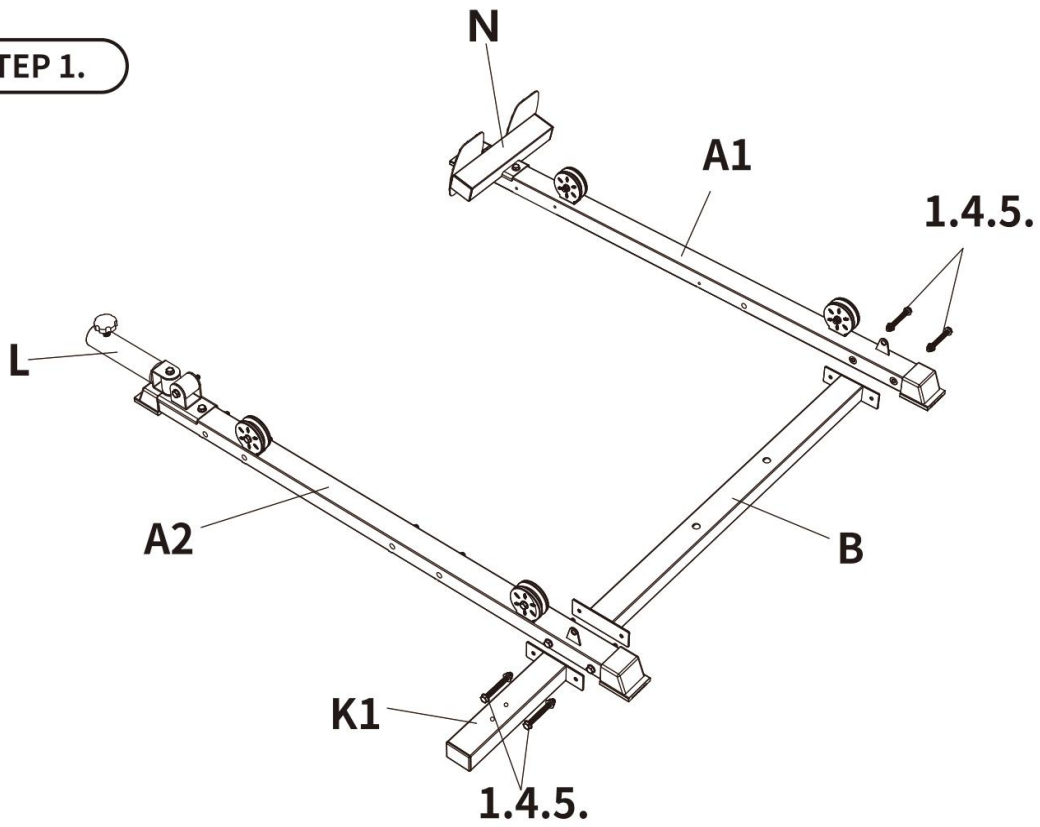

STEP 2.

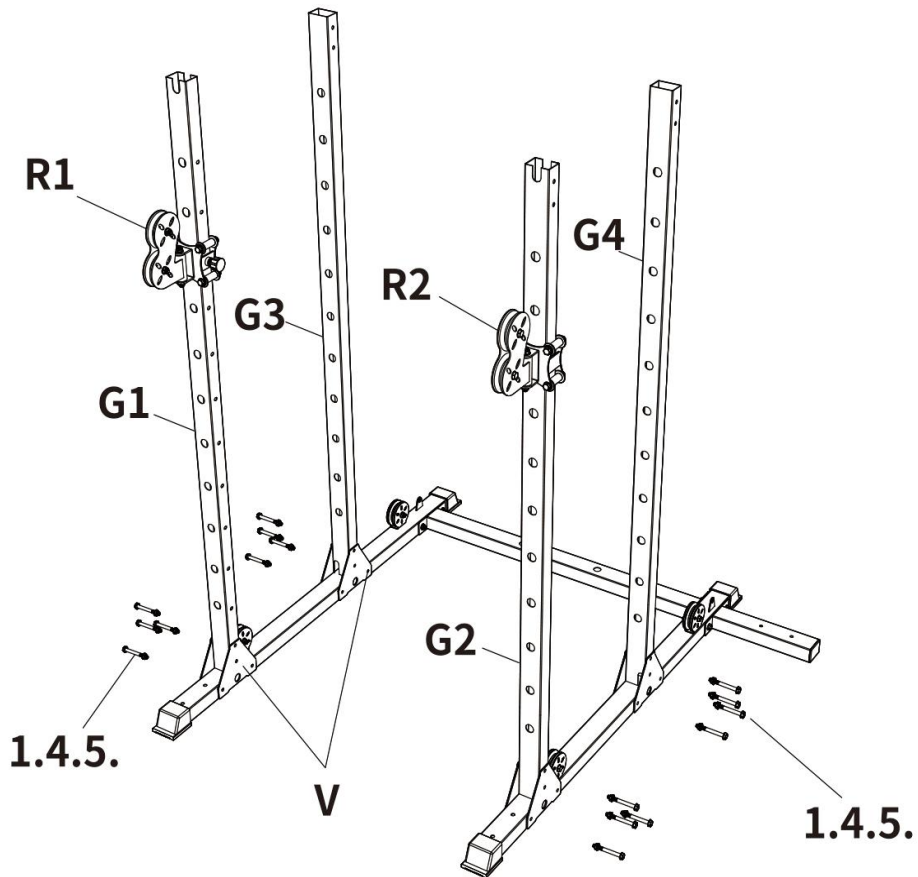

STEP 3.

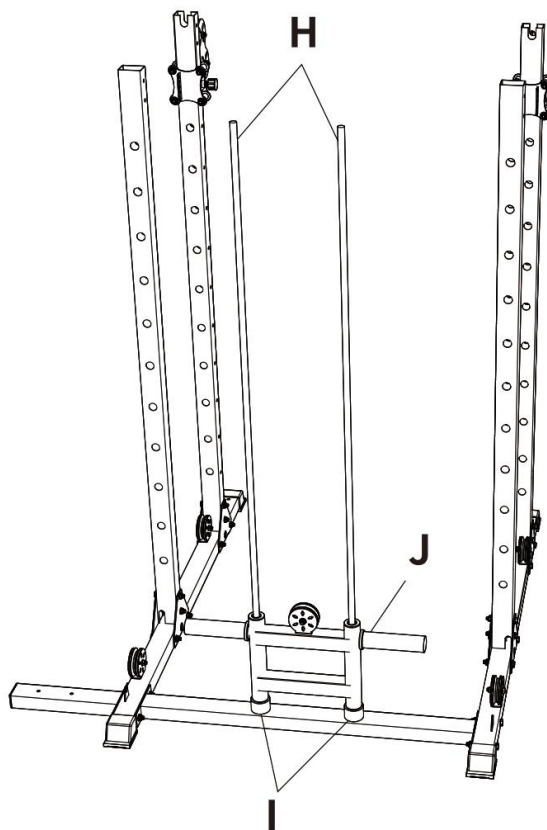

STEP 4.

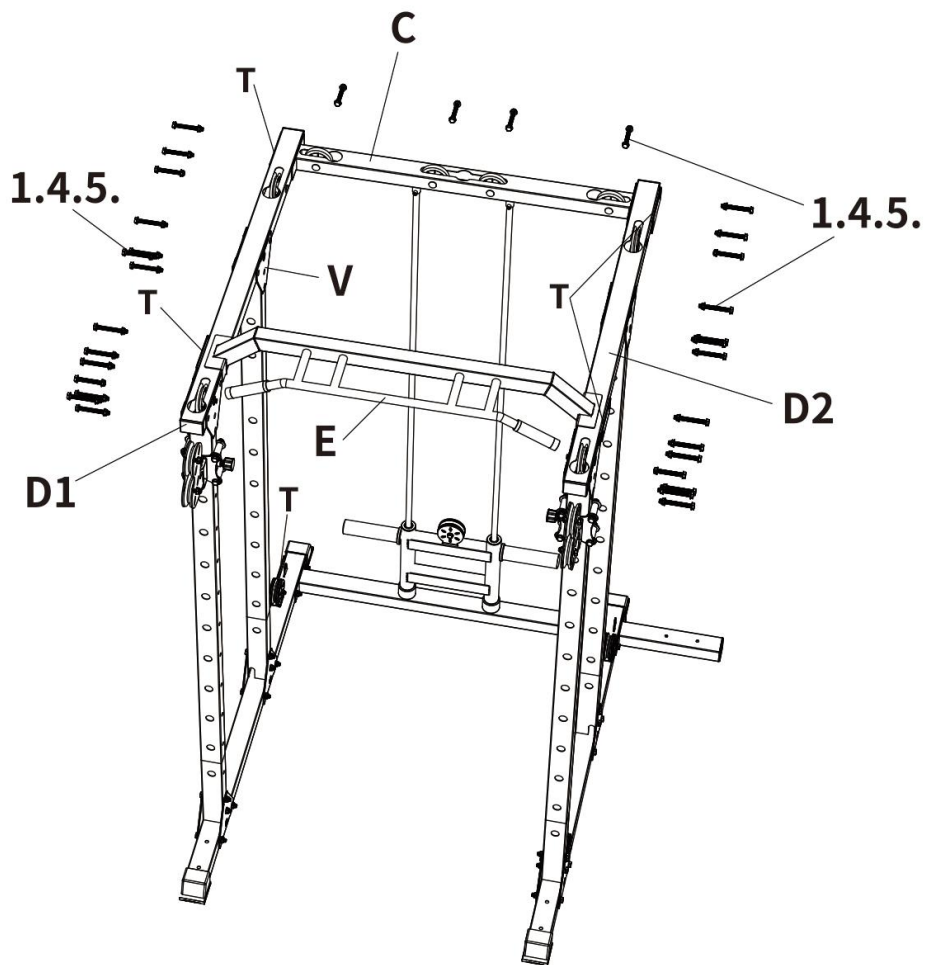

STEP 5.

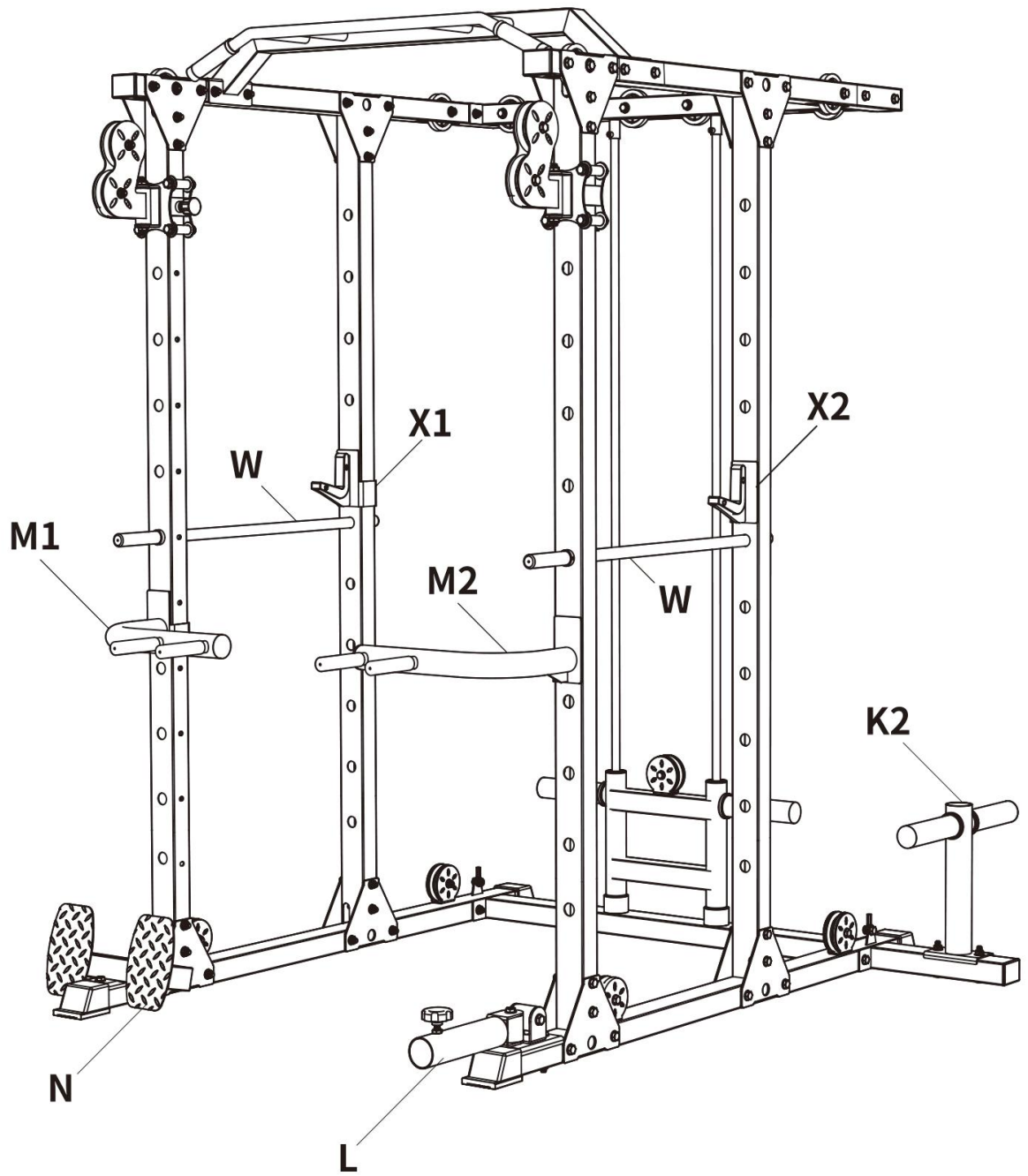

**STEP 6.**

You can adjust this cable length as you need

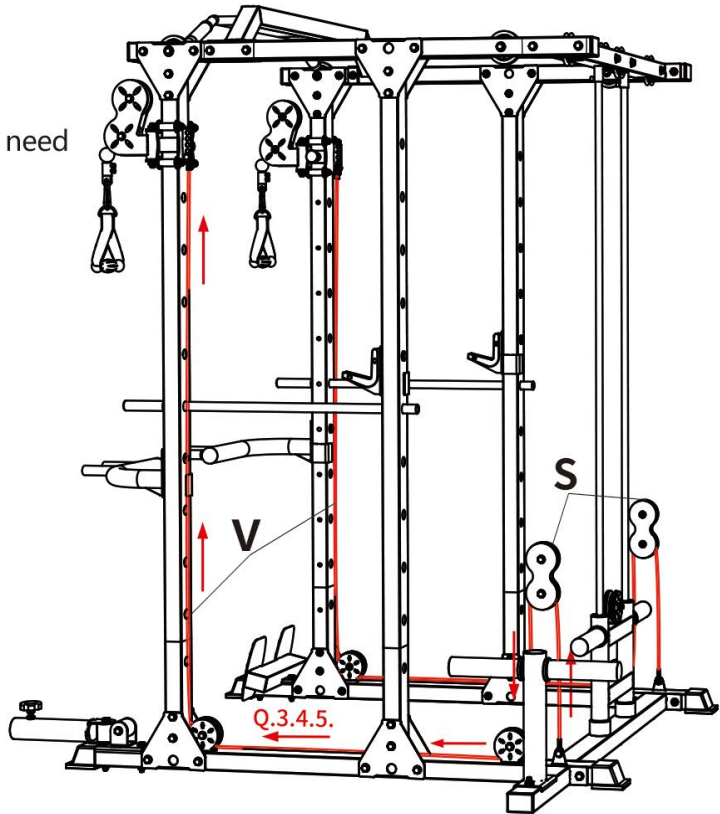
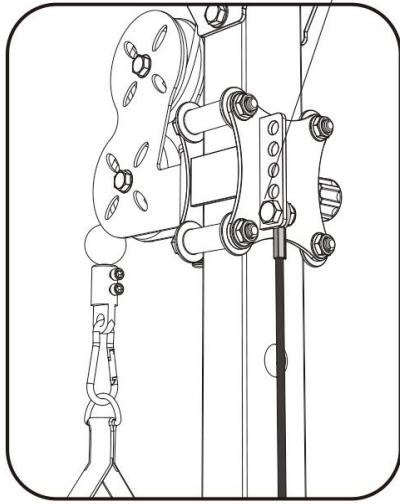

**STEP 7.**

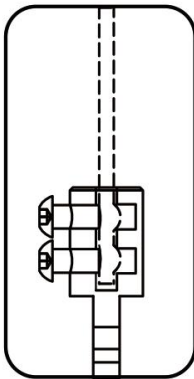

The rope must be locked tightly to prevent it from falling off

